

3-Phase Regulator Rectifier Lineup

SHINDENGEN
ELECTRIC MFG. CO., LTD



SH640 Standard Model

Outline



Connecting Diagram

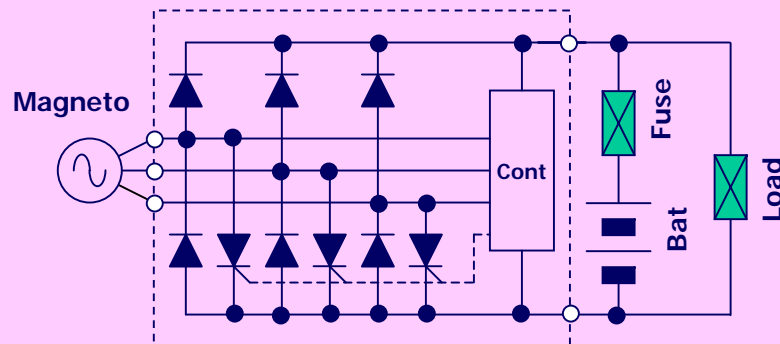

Electrical Characteristic

Item	Min	Typ	Max	Unit
Set-point	14.2	14.7	15.2	Vave
Temperature Coefficient	-3	0	+3	mV/
Output Current	-	-	25	Aave
Continuous Output Current	Refer to Ta-Io De-rating Curve			Aave

Ta-Io De-rating Curve

